



VERTUO POP+



NESPRESSO

点击并选择你的语言

CHS



安全须知



概览



网络连接



首次使用



咖啡制备



调节咖啡杯量



清洁



除垢



清空系统



恢复出厂设置



按键灯提示



故障排除



规格

安全须知

注意: 首次使用咖啡机前请仔细阅读安全须知, 以避免任何伤害和损坏。

VERTUO 机器使用技巧

1. 机器运行时请勿停止或打开。
2. 频繁使用热水冲洗可能会加速咖啡机的磨损。建议每冲煮 100 杯咖啡后进行一次冲洗。
3. 冲泡后, 请打开机器并从冲泡装置中取出胶囊。该操作设计可有效避免咖啡残留堆积, 保障萃取针头流通顺畅。

处置和环境保护

本机器依从欧盟的法规EU Directive 2012/19/EC。包装材料和机器本身均包含一些可回收材料。您的咖啡机包含一些有价值的材料, 这些材料可以被回收再利用。分类剩余的材料以便于后续回收。把机器送到收集点。您可以通过本地的相关机构获得电器处理的信息。

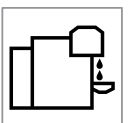
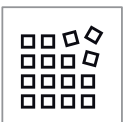

概览

机器概览

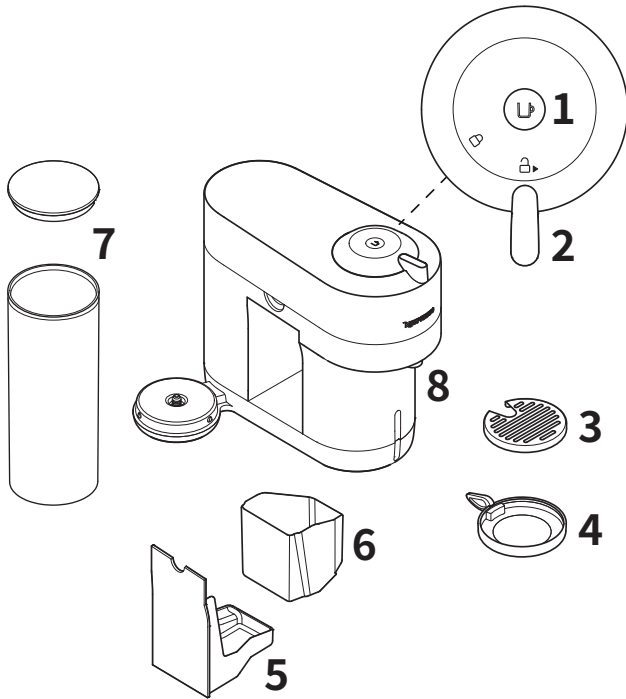

- 1 开/关与咖啡按键
- 2 锁定/解锁手柄
- 3 滴水隔栅
- 4 可调节杯托
- 5 滴水盘
- 6 废弃粉囊盒
- 7 水箱和盖子
- 8 咖啡出口

包装内容



- 1 咖啡机
 - 2 Nespresso 粉囊套装
 - 3 Nespresso 欢迎手册
 - 4 安全指示
 - 5 快速入门指南
 - 6 保修
- 4 + 5 + 6

i 开箱: 由于包装中使用了回收材料, 因此可能会有一些灰尘出现在机器表面。这没有危险, 只需用软纸巾清洁即可。

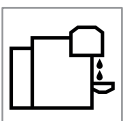
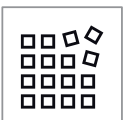
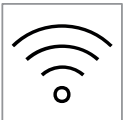

打开/关闭

打开

关闭

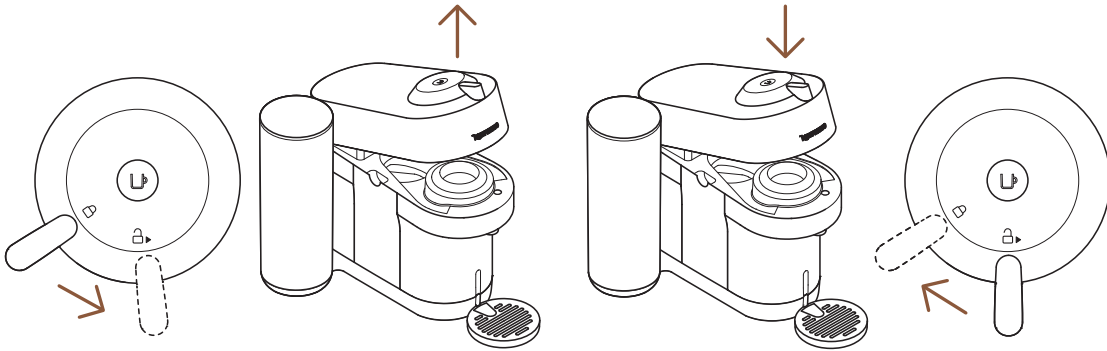

注意:为正确使用咖啡机,请勿在机器运行时打开机头,等待机器的按键变为白色后再打开。如果你想提前停止萃取,请按下咖啡按键,等待机器停止,再打开机头。

VERTUO 系统

粉囊兼容性



S
浓缩咖啡
(40 毫升)



M
双份浓缩咖啡
(80 毫升)
长杯咖啡
(150 毫升)



L
马克杯咖啡
(230 毫升)

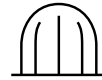

XL
超大杯咖啡,冷萃风格
(355 毫升)
分享咖啡
(535 毫升)

配件兼容性



配件兼容性



浓缩咖啡



双份浓缩咖啡



长杯咖啡



马克杯咖啡 (S)



马克杯咖啡 (M)



Reveal 冰咖啡



不合适的配件



马克杯咖啡 (L)



分享咖啡

请访问 www.nespresso.com 了解我们的全套配件系列

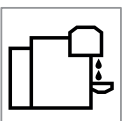
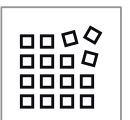
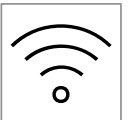

开/关

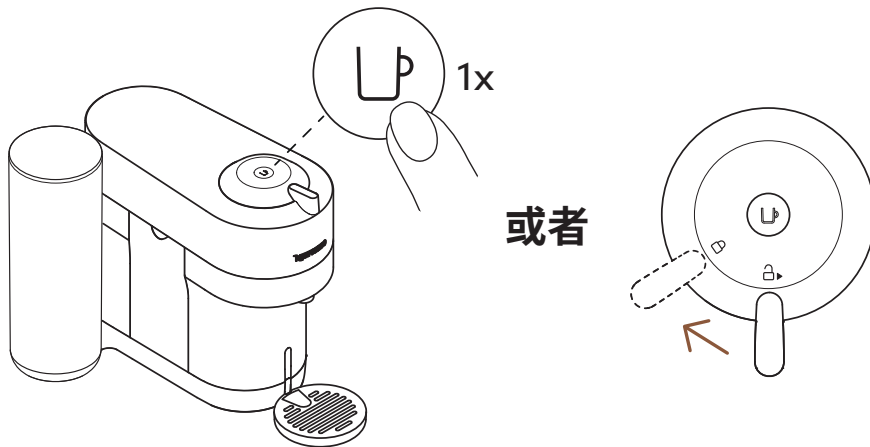

开

机器一旦插上电源, 按下按键一次或将手柄关闭在锁定位置(头部关闭)即可打开电源。

i 机器加热时, 指示灯将闪烁约30秒。一旦灯光稳定, 机器就可以使用了。



关

为节省能源, 机器在未使用2分钟后会关闭。

i 按住按键3秒钟, 机器可以随时手动“关闭”(不使用)。

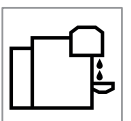
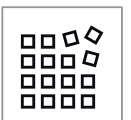

网络连接

为什么要对VERTUO POP+机器配对?

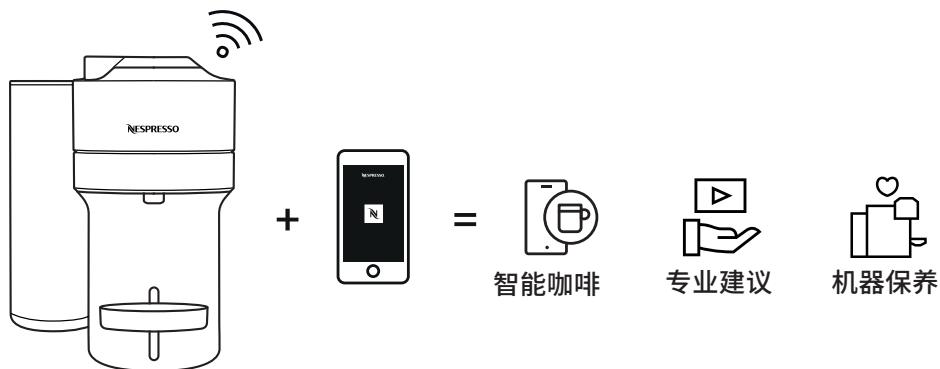

连接VERTUO POP+机器的好处?

- **智能咖啡:** 始终保持领先一步, 让你的机器保持最新状态, 了解Nespresso咖啡创新的最新信息
- **专业建议:** 通过智能手机获取支持和简单的教程视频, 伴随你的咖啡之旅
- **机器保养:** 通过收到即时通知来获得如何以及何时服务你的机器关于除垢, 冲洗, 清洁等简单的指引步骤。

如何连接你的VERTUO POP+机器?

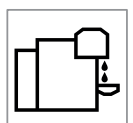

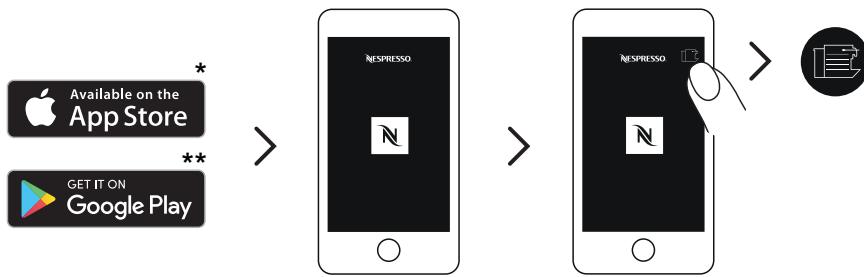

1 下载或更新**Nespresso**应用程序。在智能手机或平板电脑上启动**Nespresso**应用程序。按下屏幕右上角的机器图标。

注意:为了获得最佳性能和顺利的使用,我们建议你将机器连接到Wi-Fi路由器,而不是智能手机热点。

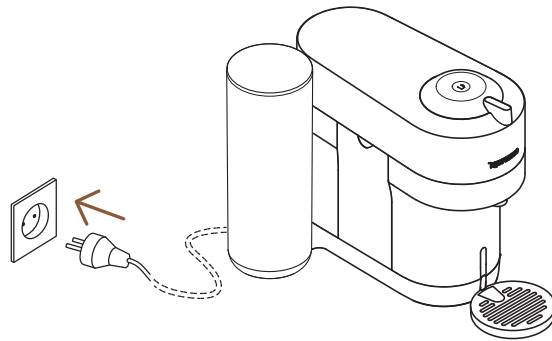

2 插上电源线。



3 通过**Nespresso**应用程序按照说明操作。

注意:首先阅读安全注意事项,以避免致命的触电和火灾风险。将机器插入电源插座时,请确保接地连接。

* App Store®是Apple Inc.在美国及其他国家和地区注册的商标。
 ** Google Play 和 Google Play 标志是 Google LLC. 的商标。

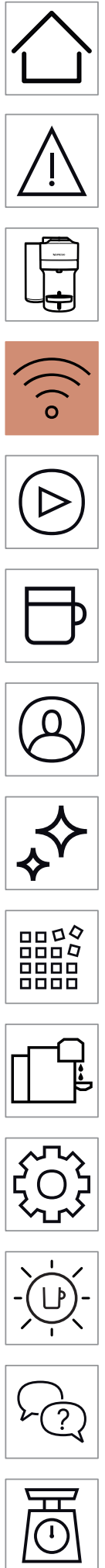

禁用机器蓝牙和WIFI

该机器附带一个连接模块, 默认情况下已启用。它提供了额外的功能, 增强了你的咖啡体验。

要禁用连接模块, 请执行以下步骤:

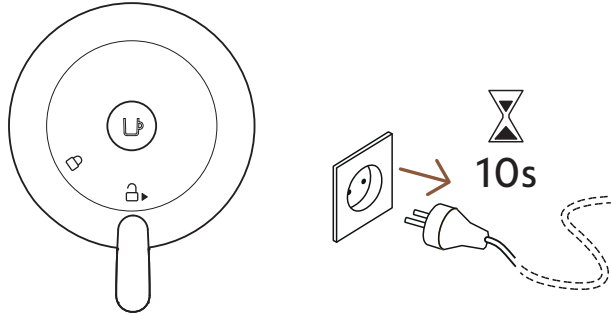

- 1** 在机器关闭且手柄处于解锁位置的情况下, 拔下机器插头至少10秒钟。

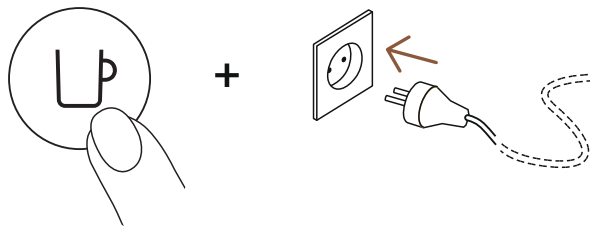

- 2** 插入电源时按住按键
该按键将闪烁橙色, 以确认连接模块现已禁用。
- i** 按照相同的步骤重新打开连接模块。
该按键将闪烁白色, 以确认模块已重新激活。

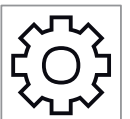
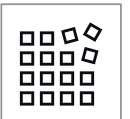

首次使用

首次冲洗

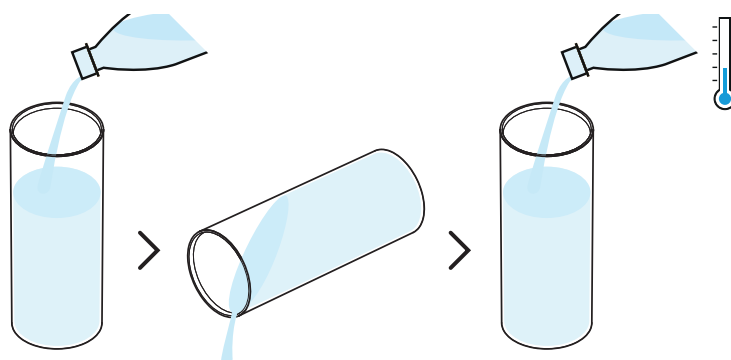
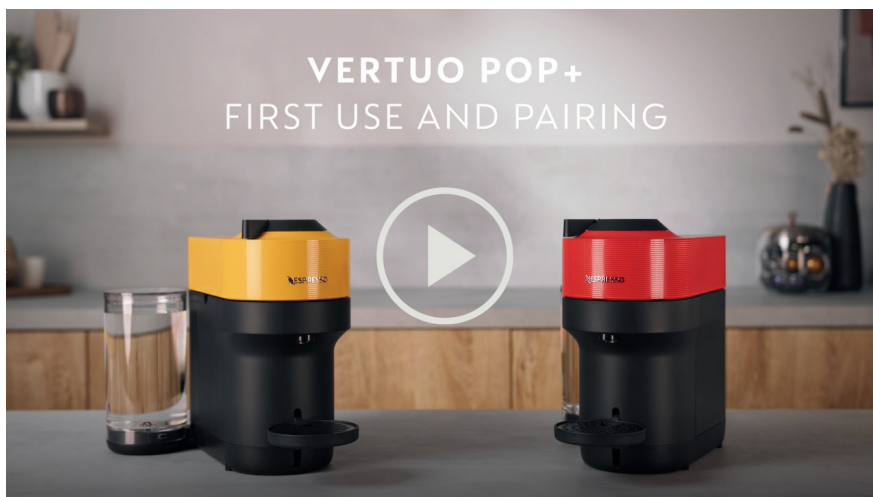

1 在注入新鲜常温饮用水之前，首先冲洗并清洁水箱和盖子。

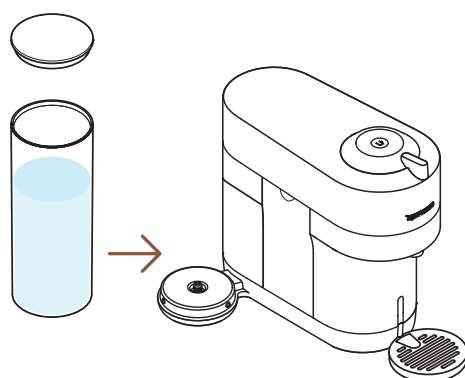

2 用盖子盖上水箱，将水箱放在适当的位置，并确保其正确连接。

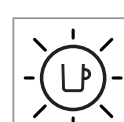
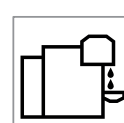
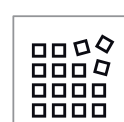
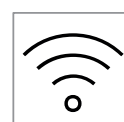
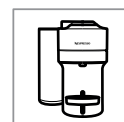

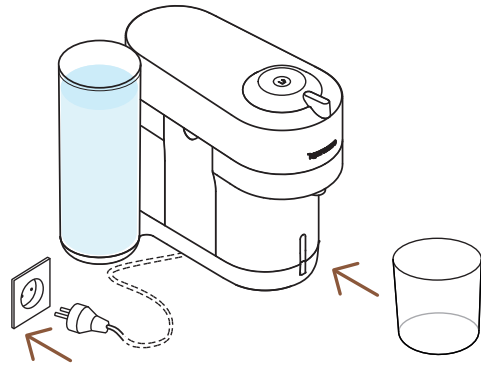

- 3** 连接电源的情况下, 取下杯托, 并在咖啡出口下方放置一个容量至少为1升的容器。

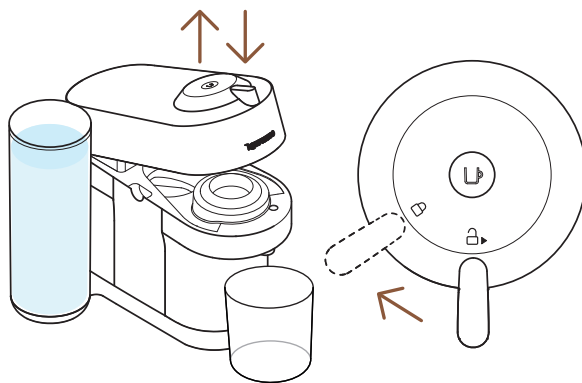

- 4** 打开并关闭机器。确保手柄处于锁定位置。

- i** 机器加热时, 指示灯会闪烁。此过程大约需要30秒。当灯光稳定时, 机器就准备好了。确保没有插入粉囊。

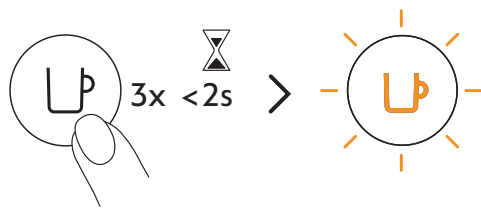

- 5** 在2秒内按下按键3次, 开始冲洗。橙灯闪烁的情况下, 让冲洗过程自动完成。当灯光变成稳定的白色时, 冲洗循环完成。

- i** 冲洗过程开始和水开始流动之前, 需要不到2分钟的时间。此过程最多可能需要 7 分钟。

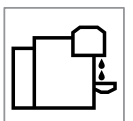
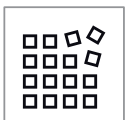
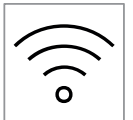

咖啡制备

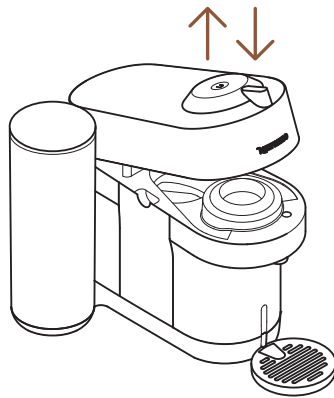

1 打开并关闭机器。

i 当机器加热时，咖啡按键指示灯将闪烁。当灯光稳定时，机器就可以使用了。

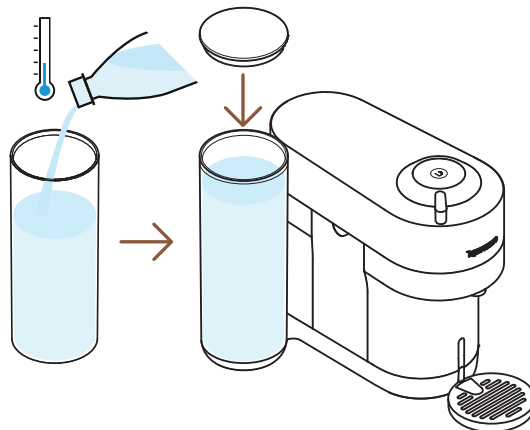

2 将新鲜常温饮用水注满水箱，然后将其放回原位。

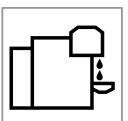
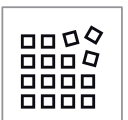

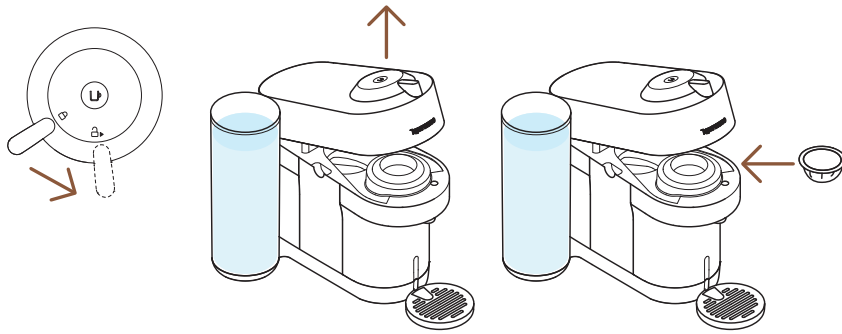

- 3** 解锁并完全打开机头，朝下插入圆顶形状的Vertuo粉囊。

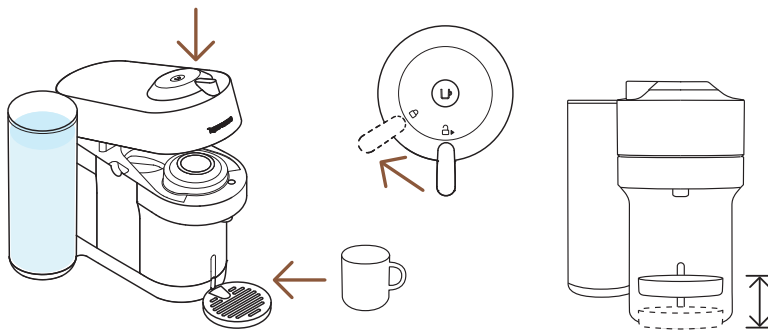

- 4** 关闭机器头部并通过向左转动手柄锁定，直到锁定位置，然后放置一个杯子。杯托可以根据你的杯子尺寸进行调整。

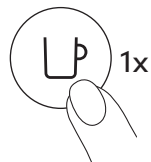

- 5** 按下一次按键即可开始萃取。

注意:为正确使用咖啡机，请勿在机器运行时打开机头，等待机器的按键变为白色后再打开。如果你想提前停止萃取，请按下咖啡按键，等待机器停止，再打开机头。

- i** 由于条形码读取、咖啡预润湿和浸泡时间，咖啡开始流出需要一段时间。该机器将自动识别插入的粉囊，并选择**Nespresso**咖啡专家定义的咖啡制备参数和杯量，以提取最佳的咖啡混合物。

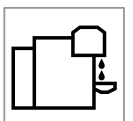
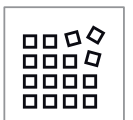
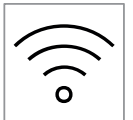

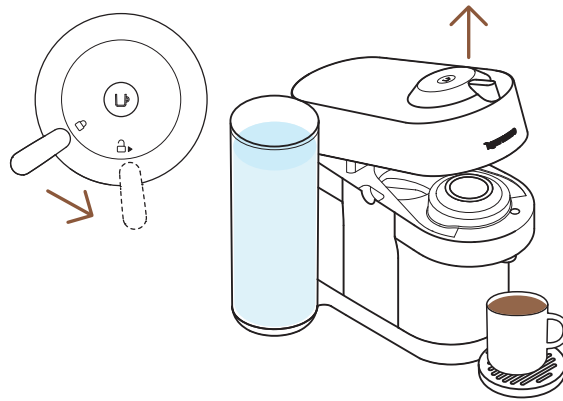

- 6** 当咖啡停止萃取时, 将手柄向右转动至解锁位置, 打开机头, 自动弹出粉囊, 享受你的咖啡。



- 7** 请勿忘记回收你的**Nespresso**咖啡粉囊。*

* **Nespresso**咖啡粉囊, 可回收的咖啡粉囊。
请登录www.nespresso.com获取更多回收信息

了解我们的咖啡创意模式



有了这台机器, **Nespresso**为你提供了一个特定的功能, 来专注于萃取属于你个人配方的咖啡。

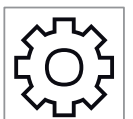
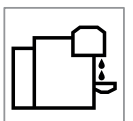
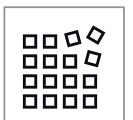
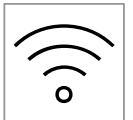

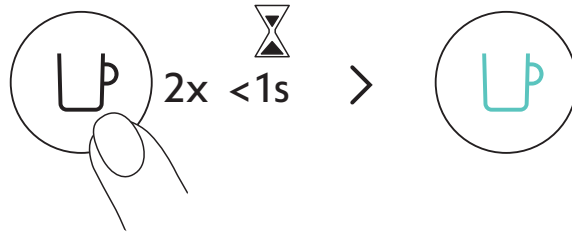

打开机器，双击咖啡按键。它会闪烁绿松石色，你会专注于咖啡萃取，通过添加添加物（牛奶、奶精、加冰等）优化配方中的咖啡味道。获得无与伦比的咖啡体验。

40 毫升	80 毫升	150 毫升	230 毫升	355 毫升	535 毫升
✓	✓	✓	✓	✗	✗
25 毫升	40 毫升	40 毫升	80 毫升		

为了充分享受这些好处，我们建议只使用官方尺寸的杯子来萃取我们的Coffee+系列。为了获得最佳的杯内效果，我们不建议用这种模式萃取我们的XL (Alto Ambrato、Alto Onice)、冷萃风格和分享咖啡风格。

注意：启用此模式可能需要通过**Nespresso**应用程序更新你的机器。



了解如何使用我们的Aeroccino系列升级你的机器，请访问www.nespresso.com

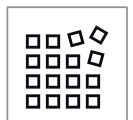

调节咖啡杯量

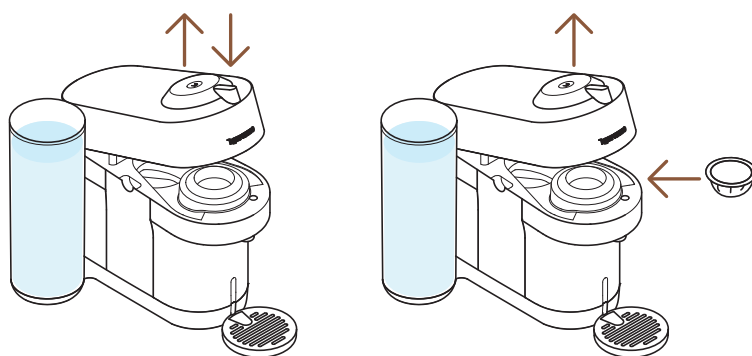

1 开机状态下, 打开机头并插入要萃取的粉囊。

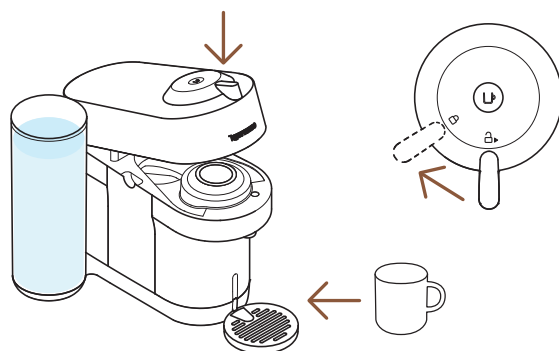

2 关闭机头, 将手柄向左转到锁定位置, 然后放置一个杯子。

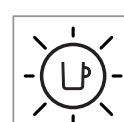
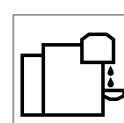
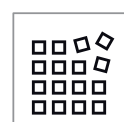
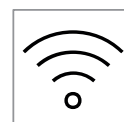
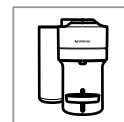

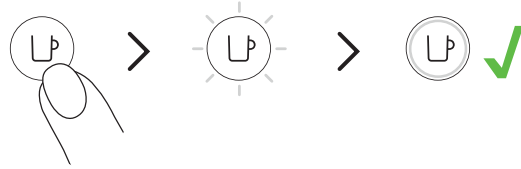

3 长按按键直至达到理想杯量的前几秒松开按键 新杯量现在已针对设置过程中使用的粉囊类型进行设定。

i 此程序针对每种粉囊类型。杯量范围为20毫升至535毫升

注意:为正确使用咖啡机,请勿在机器运行时打开机头,等待机器的按键变为白色后再打开。如果你想提前停止萃取,请按下咖啡按键,等待机器停止,再打开机头。

注意:一旦用户对客户特定的容量进行了编程,每次将该粉囊类型插入机器时,准备工作将停止在用户编程的杯量。如果你希望返回默认参数,请参阅“重置为出厂设置”一段。

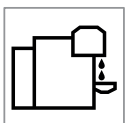
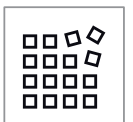

清洁

当你的机头内开始有咖啡残渣时, 或者在长时间不使用后, 每月清洁一次你的机器。

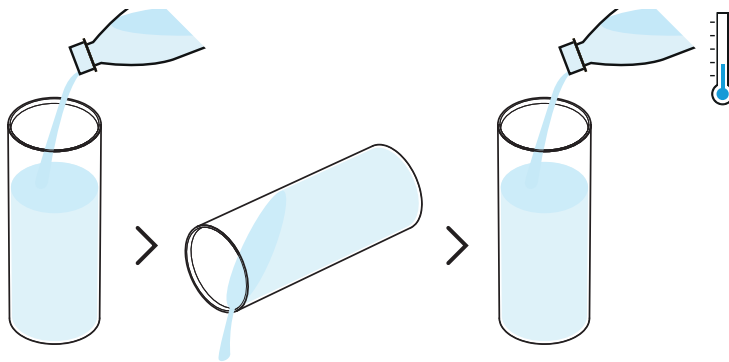

1 在装满新鲜常温饮用水之前, 先冲洗并清洁水箱和盖子。

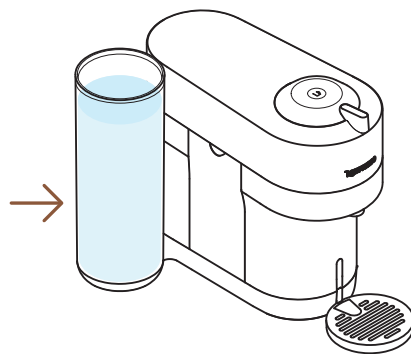

2 将水箱放回机器上的适当位置。

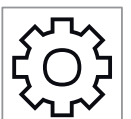
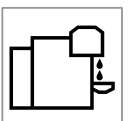
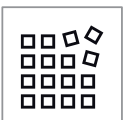

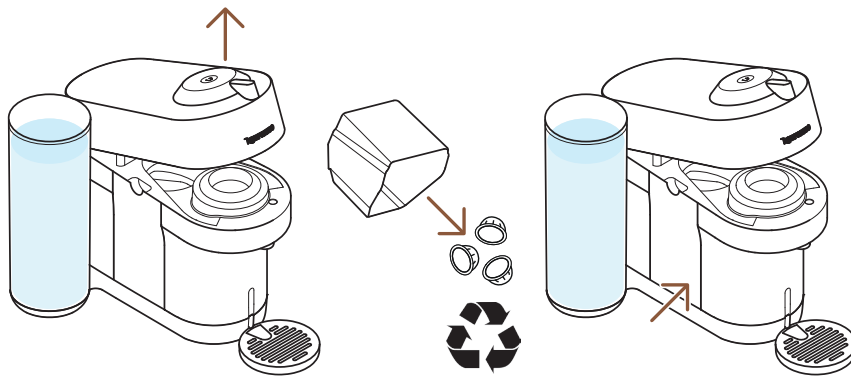

- 3** 开机状态下, 解锁并打开机头, 让用过的粉囊弹出。清空并冲洗废弃粉囊盒和滴水盘, 然后将它们放回原位。请勿忘记回收你的**Nespresso**咖啡粉囊。*

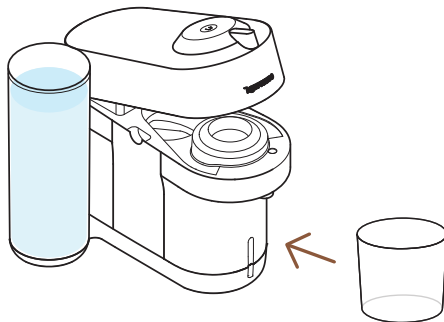

- 4** 取下杯托, 在咖啡出口下方放置一个容量至少为1升的容器。

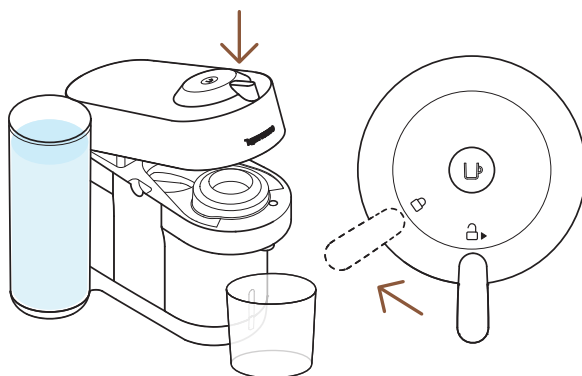

- 5** 关闭机器头部并将手柄向左转向锁定位置。在开始清洁程序之前, 确保机器中没有粉囊。

* **Nespresso**咖啡粉囊, 可回收的咖啡粉囊。
请登录www.nespresso.com获取更多回收信息

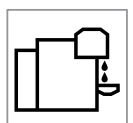

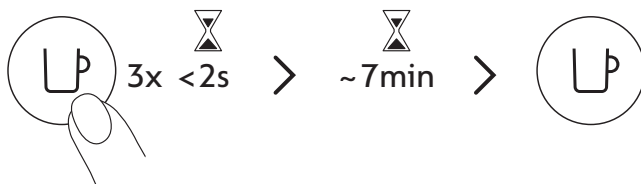

6 在2秒内按下按键3次, 开始冲洗。橙色指示灯闪烁下, 请让清洁程序自动完成。

i 在清洁过程开始和水开始流出之前, 应该需要不到2分钟的时间。此操作可能需要长达7分钟的时间, 循环完成后将自动停止。该过程可以随时通过按下按键停止。

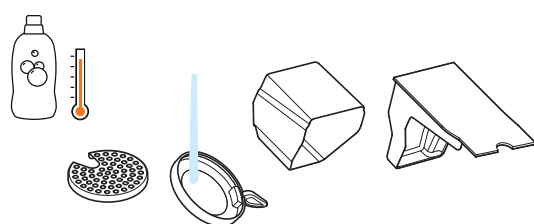

7 用热水和温和无味的洗涤剂清洗废弃粉囊盒、杯托和滴水盘。

注意: 不要使用任何强力或研磨性清洁剂或溶剂清洁剂。不要把机器放在洗碗机里。切勿将电器或其部分浸入水中。

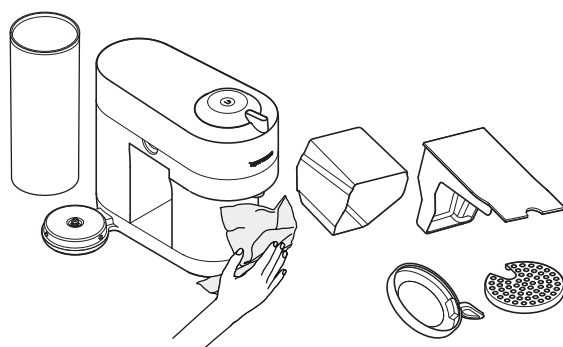

8 用干净、新鲜的毛巾擦干机器。

注意: 用干净的湿布定期清洁咖啡出口。务必使用软布清洁机器。

注意: 水可能积聚在机器头部内, 请用清洁的干布将可见部件擦干

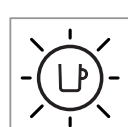
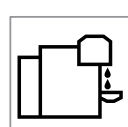
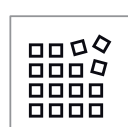
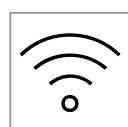

除垢

对机器进行除垢将确保其在使用寿命内正常工作，并使你的咖啡体验与第一天一样无与伦比。
你的机器将在稳定的白灯之前通过闪烁3次橙色来指示何时需要除垢。



i 除垢过程大约需要20分钟，并且不能中断。

注意:除垢开始前，请仔细阅读除垢说明

你将需要:

- 可在www.nespresso.com网站上购买除垢剂
- 一个容量为1升的容器

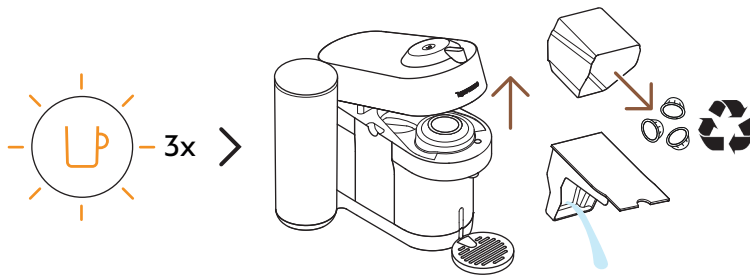

1 按键橙色闪烁3次：解锁并打开机头，让用过的粉囊弹出。清空废弃粉囊盒和滴水盘，然后将它们放回机器上的适当位置。请勿忘记回收你的**Nespresso**咖啡粉囊。*

* **Nespresso**咖啡粉囊，可回收的咖啡粉囊。
请登录www.nespresso.com获取更多回收信息

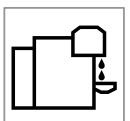
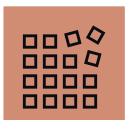

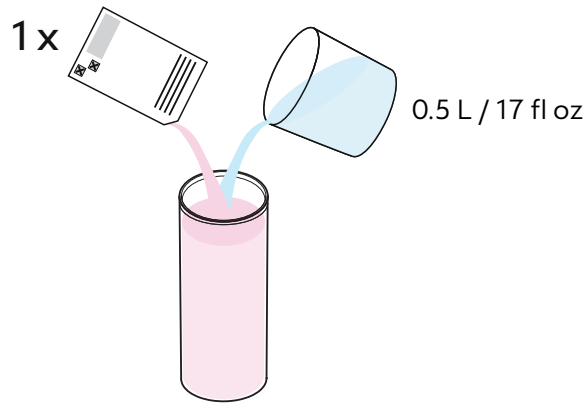

2 在水箱中加入0.5升的水, 并加入1份**Nespresso**除垢液。

注意: 请注意, 除垢液可能有害。
避免接触眼睛、皮肤和表面。

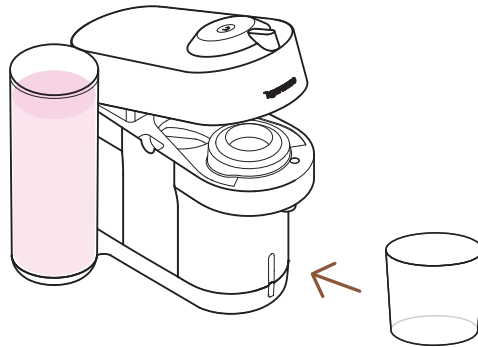

3 取下杯托, 在咖啡出口下方放置一个容量至少为1升的容器。

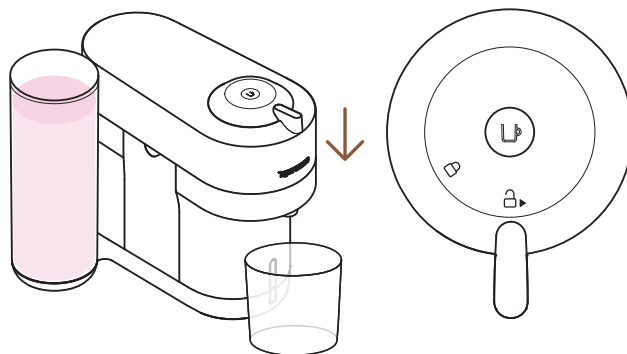

4 在机器打开的情况下, 关闭机器头部并将手柄留在解锁位置。

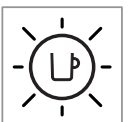
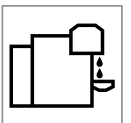
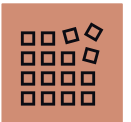
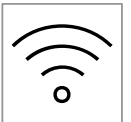

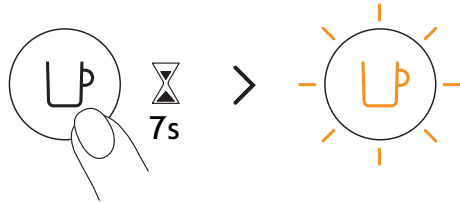

- 5** 按住按键至少7秒钟, 或者直到看到按键灯熄灭。按键灯将开始快速闪烁橙色。

注意: 你现在有45秒的时间进入除垢模式, 否则机器将返回萃取模式。

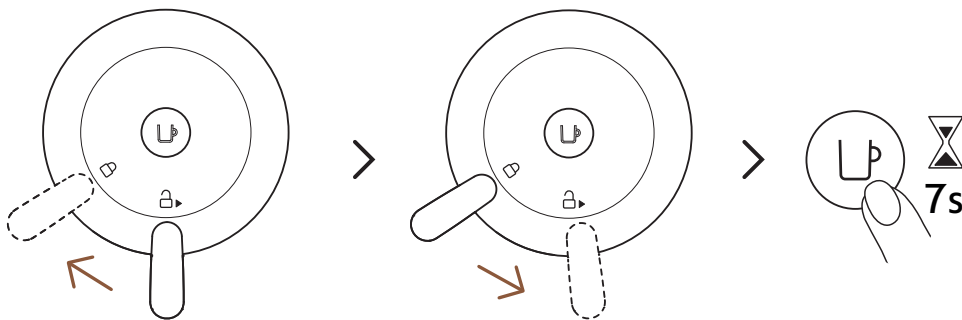

- 6** 向左转动手柄直至锁定符号, 以锁定机器头部, 然后向右转动至解锁位置, 以解锁手柄。再次按住该按键约7秒或直至指示灯熄灭。该按键将开始快速闪烁橙色。

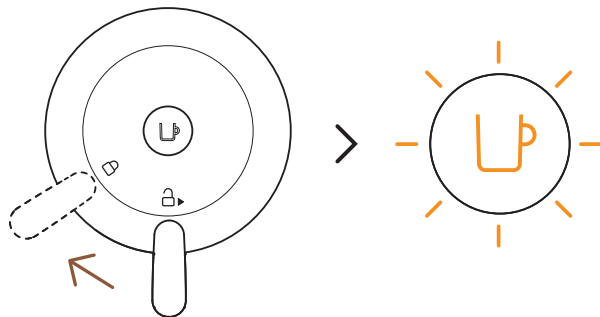

- 7** 要进入除垢模式, 请将手柄向左转动至锁定位置以锁定机器。指示灯仍应快速闪烁为橙色。这表示你已进入除垢模式。

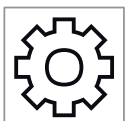
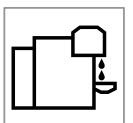
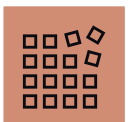

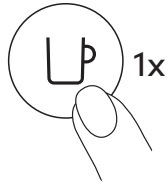

- 8** 按下咖啡按键一次, 开始除垢程序, 过程中橙色指示灯会持续闪烁。

i 第一阶段除垢完成后, 机器将自动停止。

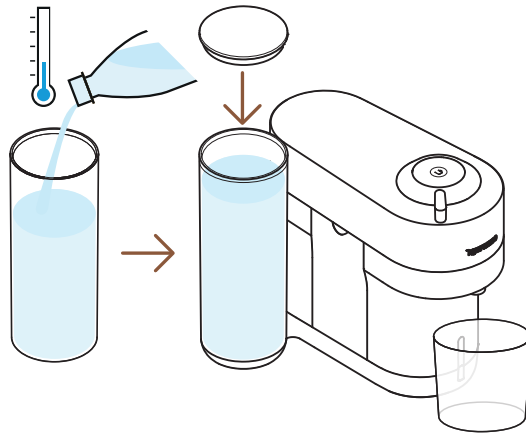

- 9** 在除垢过程结束时, 是时候冲洗机器了。
彻底冲洗水箱和滴水盘。
将新鲜常温饮用水注满水箱, 然后将其放回原位。
清空容器并将其放回咖啡出口下方。

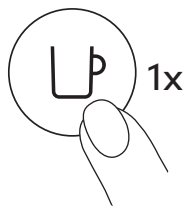

- 10** 按下按键冲洗机器。当按键灯快速停止闪烁并变得稳定时, 除垢程序完成。

i 程序完成后, 机器将自动停止。

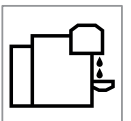
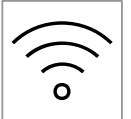

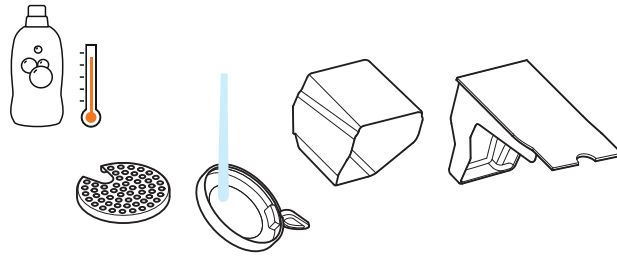

11 用热水和温和无味的洗涤剂清洗废弃粉囊盒、杯托和滴水盘。

注意: 不要使用任何强力或研磨性清洁剂或溶剂清洁剂。不要把机器放在洗碗机里。切勿将电器或其部分浸入水中。

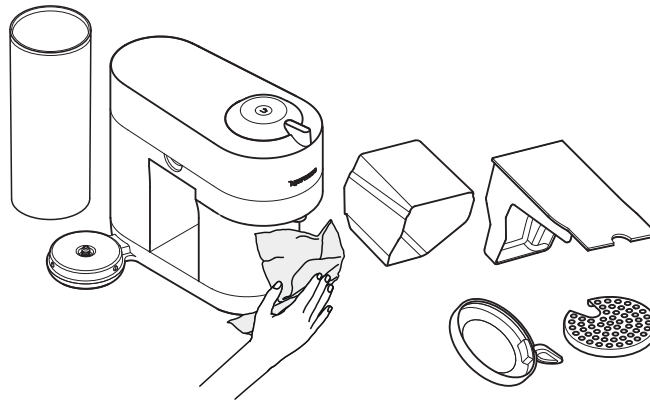

12 用干净、新鲜的毛巾擦干机器。让机器干燥10分钟后再使用。

注意: 清洗过程中, 机器头部可能会积水。如果出现这种情况, 请用干净的干布擦干可见部分。

注意: 只有在萃取了30杯或30杯以上的咖啡后, 机器才能进入除垢模式。

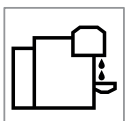
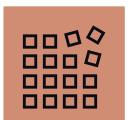
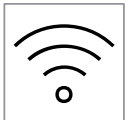

清空系统

清空程序是一个可以在一段时间不使用之前、为了防冻或在送机器维修之前进行的过程。

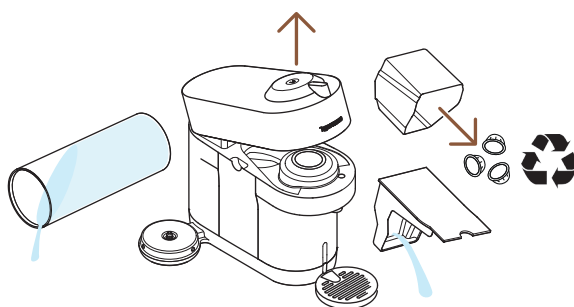

- 1** 清空水箱, 打开机头, 让用过的粉囊弹出。
清空废弃粉囊盒和滴水盘。
请勿忘记回收你的**Nespresso**咖啡粉囊。*

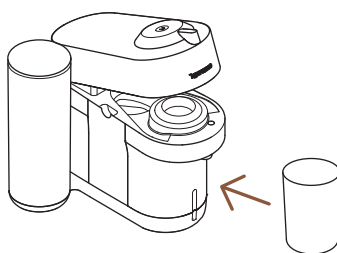

- 2** 将它们放回机器上的适当位置, 取下杯托, 并在咖啡出口下方放置一个容量至少为0.5升的容器

* **Nespresso**咖啡粉囊, 可回收的咖啡粉囊。
请登录www.nespresso.com获取更多回收信息

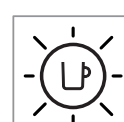
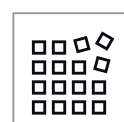
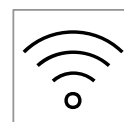
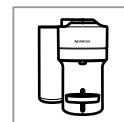

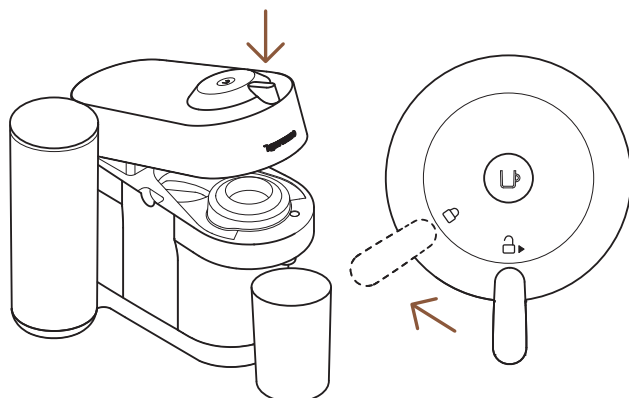

3 在连接电源及开机状态下, 将手柄转向锁定位置。

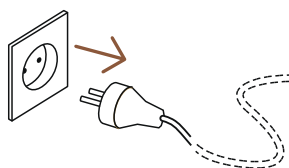

4 拔下机器电源插头。

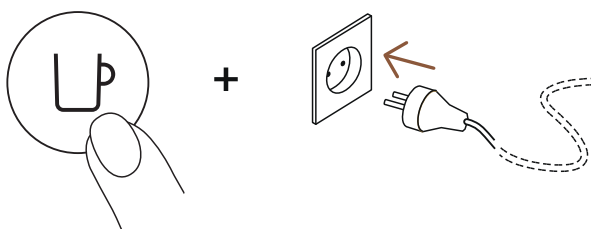

5 插入电源时按住按键。

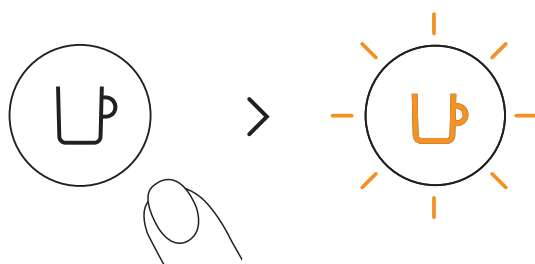

6 松开按键。
它将闪烁橙色, 排空过程将开始。

i 机器完成排空过程大约需要30秒。
机器空的时候自动关机。

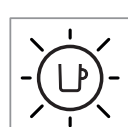
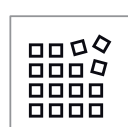
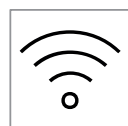
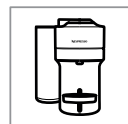

恢复出厂设置

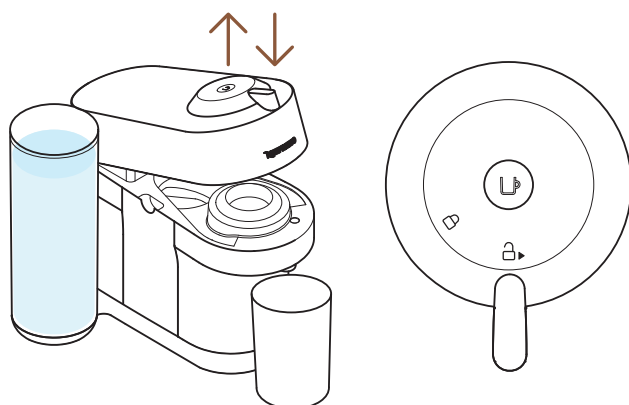

- 1** 在机器连接电源情况下, 打开并关闭机头, 然后将手柄留在解锁位置。

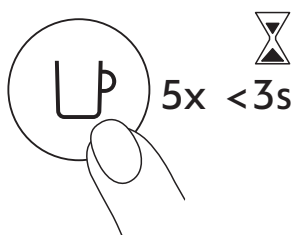

- 2** 3秒内按下按键5次 机器现在已按照出厂设置进行编程。

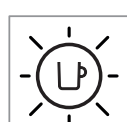
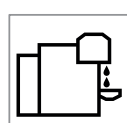
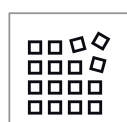
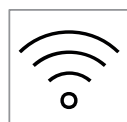
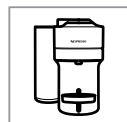

按键灯提示

你想知道更多关于Vertuo Pop+闪灯的信息吗？
请观看以下视频：

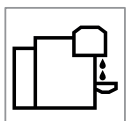
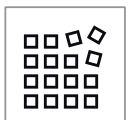

故障排除

按键没有灯亮

- 机器已经自动关机;按下按键或“解锁”机器。
- 检查电源、插头、电压和保险丝。

不出咖啡, 不出水。

- 检查水箱是否有水。
- 检查新的粉囊放置在正确的位置, 手柄已正确锁定, 然后按下按键开始。
- 如果必要请除垢。
- 打开机头, 让粉囊弹出。然后按照清洁章节指示进行清洁。

咖啡不够热。

- 用可饮用热水预热杯子。
- 如果必要请除垢。

渗漏或咖啡异常流量。

- 检查水箱位置是否正确。
- 如果必要请除垢。

机器转到“关闭模式”。

- 为节省能源, 机器在未使用2分钟后会关闭。
- 按住按键3秒钟, 机器可以随时手动“关闭”(不使用时)。

杯中残留咖啡渣。

- 执行两次清洁程序。
- 请查阅“清洗”章节。

机器无法启动, 并且按键灯一直亮着。如果按键灯闪烁, 请查阅后续要点。

- 检查手柄是否正确锁定。
- 如果你想萃取一杯咖啡或浓缩咖啡, 请检查未使用的粉囊是否已正确放置, 手柄是否正确锁定, 然后按下按键开始。
- 如果你想清洗、除垢或清空系统, 请检查机器未放入粉囊, 然后关闭锁定机器, 按下按键开始其中之一的操作。

机器无法启动, 按键闪烁交替:1次闪烁与1次暂停。

- 水箱加水然后按键开始。
- 检查手柄是否正确锁定。

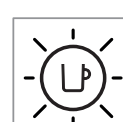
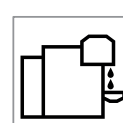
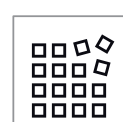
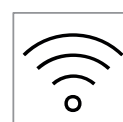
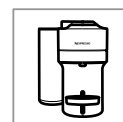

机器运行中按键闪烁。

- 如果出咖啡正常, 表示机器正常工作中。
- 如果只有水在流动, 则机器正在执行用户对系统进行清洁、除垢或排空的请求。请参考相应章节内容。
- 按下按键3秒钟, 将机器转到“关闭模式”, 然后再次按下按键以打开机器。
现在等待大约20分钟, 让机器在大量使用后冷却下来。

机器无法启动, 按键闪烁交替:1次闪烁与1次暂停。

- 咖啡出来前需要等待一段时间(条形码读取及浸泡咖啡)。
- 检查新的粉囊放置在正确的位置, 手柄已正确锁定, 然后按下按键开始。
- 水箱加水然后按键开始。
- 按下按键3秒钟, 将机器转到“关闭模式”, 然后再次按下按键以打开机器。
现在, 等待大约20分钟, 让机器在大量使用后冷却下来。

按键交替闪烁:持续2次闪烁与1次暂停。机器没有运行。

- 在正常咖啡/浓缩咖啡制备中:
 - 1) 解锁手柄, 打开机头检查未使用且完好的粉囊放置在正确位置。
 - 2) 检查手柄在“锁定”位置。
 - 3) 检查水箱是否有水。
- 在除垢、清空与清洗中:
 - 1) 检查粉囊已弹出。
 - 2) 检查手柄在“锁定”位置。
- 在杯量识别程序中:
 - 1) 检查粉囊是否插入良好。
 - 2) 请参考相应章节内容。
- 如果问题仍然存在:
 - 1) 解锁手柄然后打开机头。
 - 2) 更换粉囊(如果需要)。
 - 3) 拔下电源插头, 然后10秒后重新插上电源插头。
 - 4) 合上机头, 然后按下按键开机, 然后再次按键开始萃取。
 如果问题依然存在, 请联系 **Nespresso**。

按键灯交替闪烁3次后稳定发光。

- 建议除垢: 当此警告仅出现几次时机器可以操作, 但是如持续出现, 则有必要进行除垢。

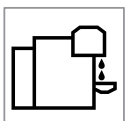
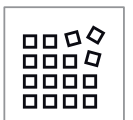
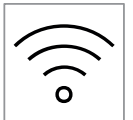

规格

功率	~220-240 V, 50-60 Hz, 1300-1500 W US, CA: 120 V, 60 Hz, 1500 W MX: 127 V~, 60 Hz, 1650 W CN: 220 V~, 50 Hz, 1300 W
频率	2.402-2.480 GHz
射频输出功率(EIRP)	蓝牙4 dBm最大射频输出功率和Wi-Fi小于20 dMm最大射频输出功率
待机	0.38 W
省电模式	自动关机:2分钟
加热时间	30秒(头部闭合并锁定)
适用于大型配方的可移动杯托	有两处可调节的位置
从设备调度开始的电缆长度	90 厘米 / 35.4 英寸
尺寸(长x宽x高)	22 x 35.6 x 26.5 cm / 8.6 x 14 x 10.4 in
重量	3.7 kg / 8.1 lbs
水箱容量	1.1 L / 37.2 fl oz
废弃粉囊盒容量	8个意式浓缩咖啡或5个马克杯咖啡粉囊

机器代码

Nespresso	Breville	Delonghi
GCV6 GDV6	BNV520, BNV550, BNV530, BNV560, BNV540, BNV570	ENV92B, ENV92BAE, ENV92Y, ENV92YAE, ENV92AAE, ENV95S, ENV95SAE
Magimix	Krups	
M800	XN930T10, XN930T40, XN930TCH	

